



FICHE D'HOMOLOGATION / HOMOLOGATION FORM



COMMISSION
INTERNATIONALE
DE KARTING - FIA

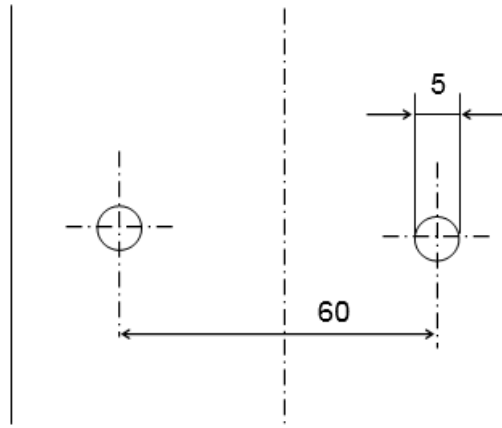

PNEUMATIQUE / TYRE 5" SLICK MINI

Constructeur / <i>Manufacturer</i>	Bridgestone Corporation
Marque / <i>Make</i>	Bridgestone
Modèle / <i>Model</i>	5.0/11.0-5 DR1 YPM
Catégorie / <i>Categorie</i>	Group 3
Durée de l'homologation / <i>Validity of the Homologation</i>	3 ans / 3 years
Nombre de pages / <i>Number of pages</i>	4
La présente Fiche d'Homologation reproduit descriptions, illustrations et dimensions du pneumatique au moment de l'homologation CIK-FIA.	<i>This Homologation Form reproduces descriptions, illustrations and dimensions of the tyre at the moment of the CIK-FIA homologation.</i>
	
Photo du pneu monté sur la jante / <i>Photo of the tyre fitted to the rim</i>	Dessin de la bande de roulement / <i>Tread design drawing</i>
Signature et tampon de l'ASN / <i>Signature and stamp of the ASN</i>	Signature et tampon de la CIK-FIA / <i>Signature and stamp of the CIK-FIA</i>
	

Descriptions Techniques	Technical Descriptions
Sous une température de 23°C +/-2°C, avec une humidité de 50% +/-5%	At a temperature of 23°C +/-2°C and with a humidity of 50% +/-5%

Pt	Descriptions / Descriptions	Valeurs / Value		Tolérances / Tolerances	
1	Dimensions / Dimensions	5.0/11.0-5		--	
2	Désignation du mélange / Tread compound designation	YPM		--	
3	Pression de service / Service pressure	0.8 bar		+/- 0.3 bar	
4	Pression de gonflage / Inflation pressure	4.0 bar		max.	
5	Capacité de charge / Load capacity	620 N		max.	
6	Vitesse maximale / Maximum speed	200 km/h			
7	Rigidité latérale et verticale (sous charge de 40 kg) / Lateral and vertical stiffness (under 40 kg load)	L : 1 mm V : 11 mm		L: +/-1 V: +/-2	
8					
9	Profondeur du profil / Depth of tread	4.0 mm		+/- 0.5 mm	
10	Poids en grammes / Weight in grams	1204		+/- 10%	
11	Nombre de plis / Numbers of plies	2		--	
12	Épaisseur de la bande de roulement / Tread thickness	4.8 mm		+/- 1.0 mm	
13	Nombre d'indicateurs d'usure du pneu / Number of tread wear indicators	8		--	
14	Matériau de la carcasse / Carcass material	Polyester		--	
15	Angle de tissage de la toile du pneu / Angle of tyre canvas	29°		+/- 3°	
16	Type de fil de tissage (selon ISO) / Canvas thread type (according to ISO)	1100 dtex		--	
17	Pneu tubeless / Tubeless tyre	Yes		--	
18	Dureté superficielle de la bande de roulement (ISO 48:2018 – 2 échantillons de 2 mm d'épaisseur) / Superficial tread hardness (ISO 48:2018 – 2 samples of 2 mm thickness)	57.7		+/- 5 DIDC - IRHD	
19	Contrainte-déformation en traction (ISO 37:2017 – éprouvette type 3) / Tensile stress-strain (ISO 37:2017 – type 3 sample)	à / at 100%	à / at 300%	à / at 100%	à / at 300%
		2.1	8.7	+/- 0.5 MPa	+/- 0.8 MPa
20	Largeur de la bande / Tread width (ASTM F870-94 2016)	68 mm		Arriere/Rear: max. 120 mm	

Dessin

Drawing

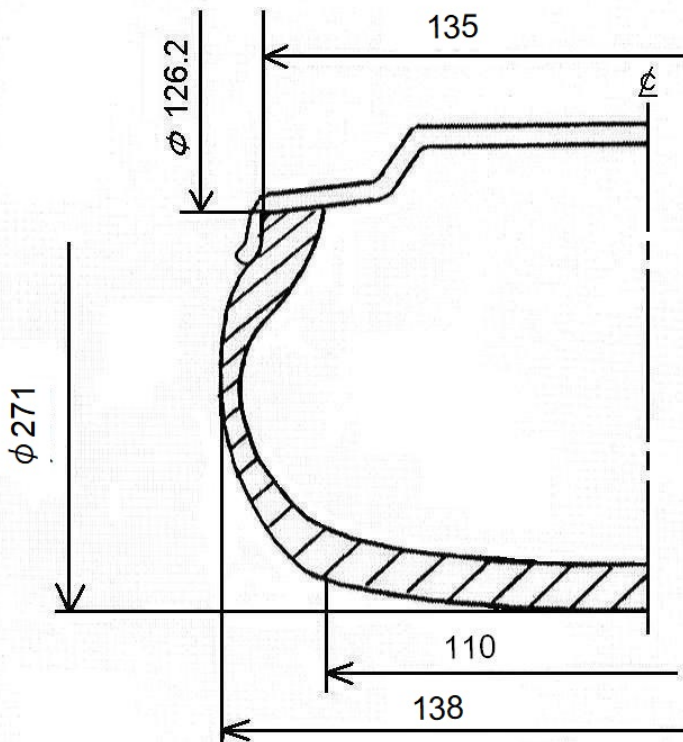
Dessin du pneu en section transversale et dimensions du pneu monté sur une jante / Drawing of tyre cross section and dimensions of the tyre fitted to a rim	Dimensions / Dimensions	Tolérances / Tolerances
	Ø 271 mm	+/- 7.0 mm
	Ø 126.2 mm*	+0/-1.0 mm
	138 mm	+/- 5.0 mm
	110 mm	+/- 5.0 mm
	135	+/- 5.0 mm
<p>*Dimension selon Dessin Technique N° 4 jante 5" standardisée / Dimension according to Technical Drawing N° 4 standardised 5" rim</p>		

DESSIN TECHNIQUE N°4

Jante 5"

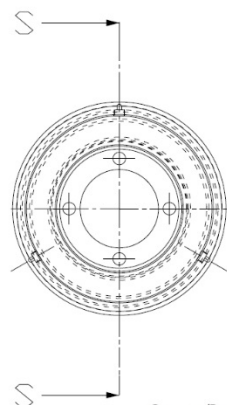

Cotes en/Dimensions in mm

TECHNICAL DRAWING No. 4

5" Rim

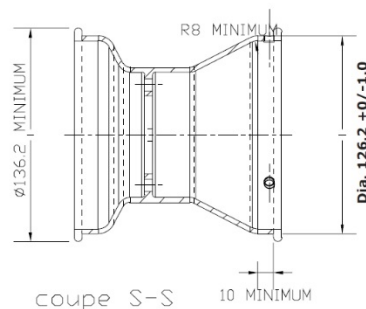

coupe S-S 10 MINIMUM

Photos et Inscriptions	<i>Photos and Inscriptions</i>		
Seules les inscriptions qui ne changeront pas tout au long de la fabrication sont reportées ci-dessous.	<i>Only the inscriptions which will not change during production are mentioned below.</i>		
Photo du flanc extérieur du pneu / <i>Photo of tyre external sidewall</i>	Inscription sur le flanc extérieur du pneu / <i>Inscriptions on tyre external sidewall</i>		
	Texte / Text	Hauteur / Height	Trait / Stroke
	CIK	5.0 mm	2.0 mm
	Mini	5.0 mm	1.5 mm
	5.0/11.0-5	6.3 mm	2.0 mm
	DR1	3.2 mm	0.3 mm
	YPM	5.0 mm	2.0 mm
	TUBLESS	4.0 mm	0.5 mm
	MADE IN JAPAN	3.2 mm	0.3 mm
	FOR RACING PURPOSE ONLY	4.0 mm	0.5 mm
	MAX. INFLATION PRESSURE 4.0KG/CM2	4.0 mm	0.5 mm
	(MOLD No.)	3.2 mm	0.3 mm
	BRIDGESTONE(PRINT)	15.0 mm	2-6 mm
	ROTATION	4.0 mm	0.5 mm
	8.0 mm		
Photo du flanc intérieur du pneu / <i>Photo of tyre internal sidewall</i>	Inscriptions sur le flanc intérieur du pneu / <i>Inscriptions on tyre internal sidewall</i>		
	Texte / Text	Hauteur / Height	Trait / Stroke
	5.0/11.0-5	6.3 mm	2.0 mm
	DR1	3.2 mm	0.3 mm
	TUBLESS	4.0 mm	0.5 mm
	MADE IN JAPAN	3.2 mm	0.3 mm
	FOR RACING PURPOSE ONLY	4.0mm	0.5mm
	MAX. INFLATION PRESSURE 4.0KG/CM2	4.0mm	0.5mm
	(MOLD No.)	3.2 mm	0.3 mm
	BRIDGESTONE	12.5 mm	2-5 mm
	ROTATION	4.0 mm	0.5 mm
		8.0 mm	